

Matière inox 304L ou 316L svt demande client
 finition microbillée ou peint svt demande client

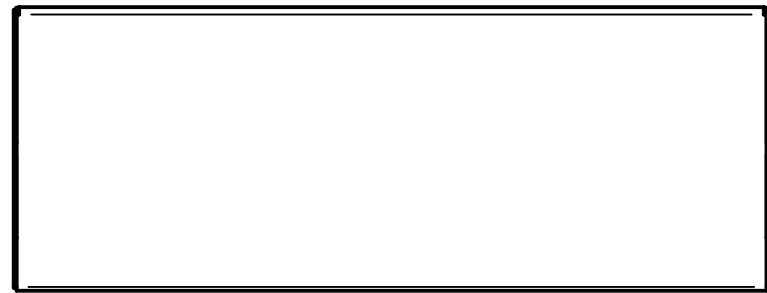
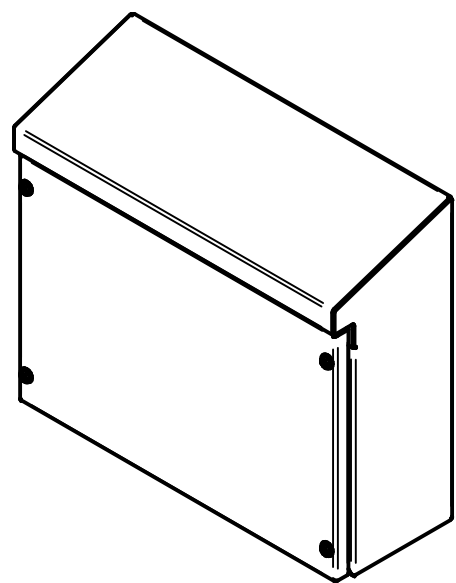
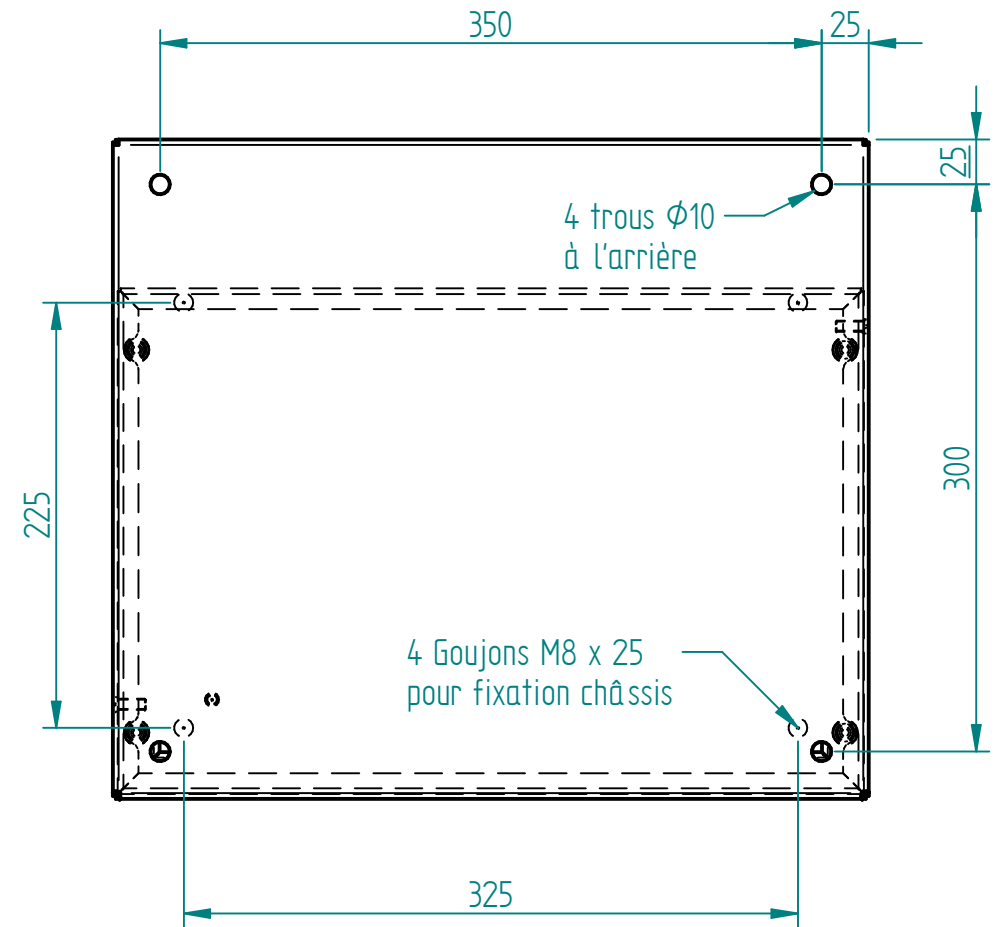
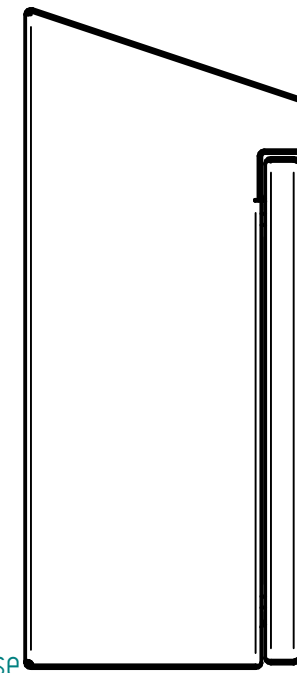
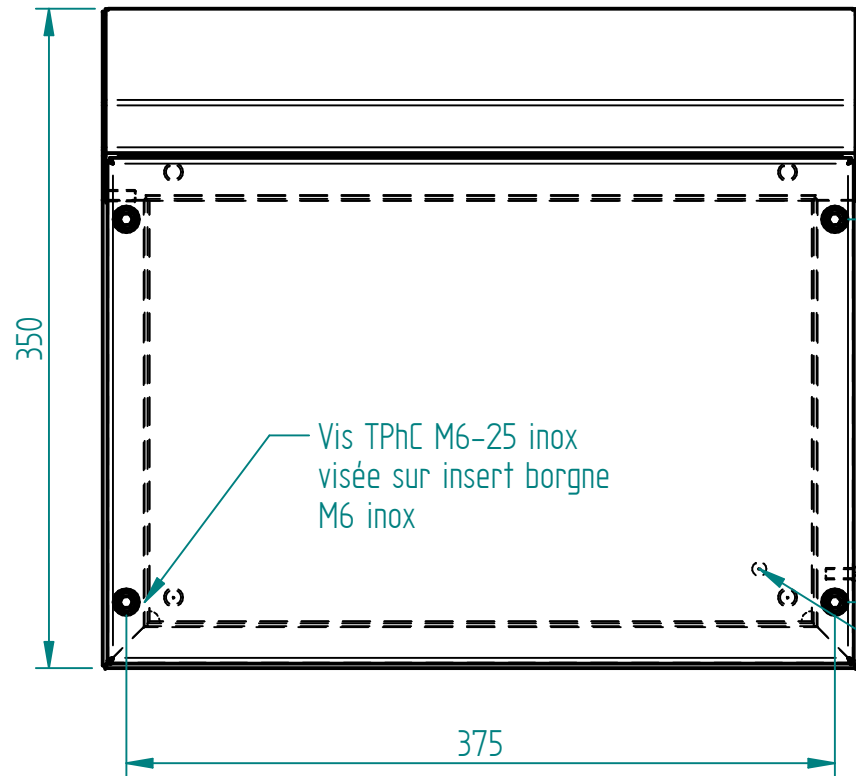
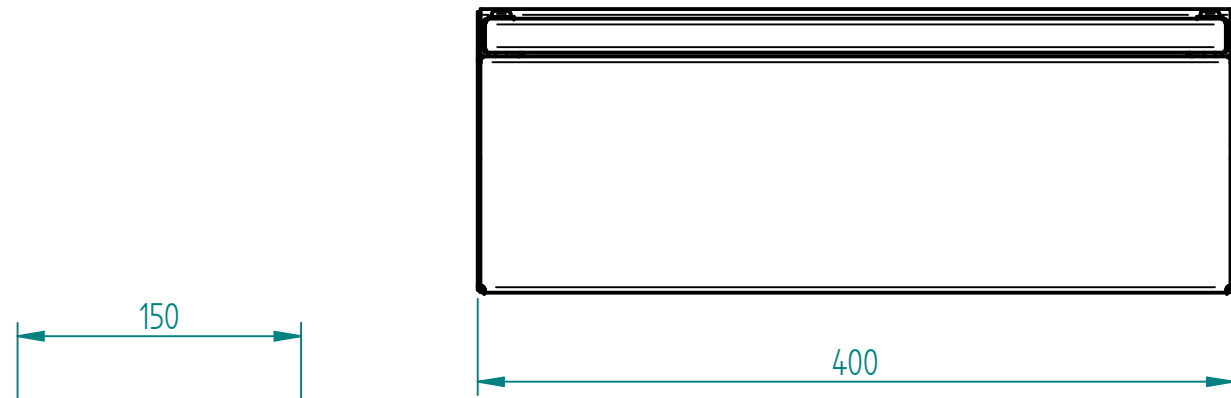

Joint EPDM extrudé 20x11 intérieur couvercle

Ind	Nom	Date	Commentaires
Matière :		Nom du projet : BOITIER-350x400x150-T15°	
Echelle : 1:4	Feuille : 1 / 1	Client :	
		Document n° : BX6I304015 ou BY6I304015	
MARBORE			