

Matière inox 304L ou 316L svt demande client
 finition microbillée ou peint svt demande client

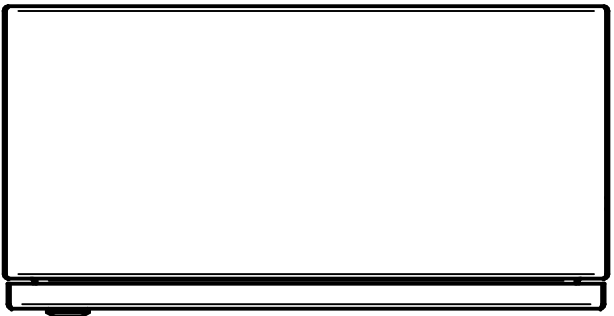
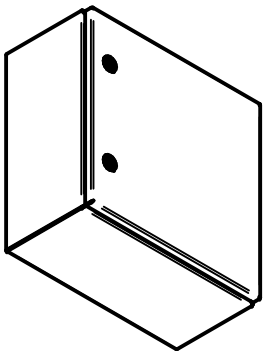
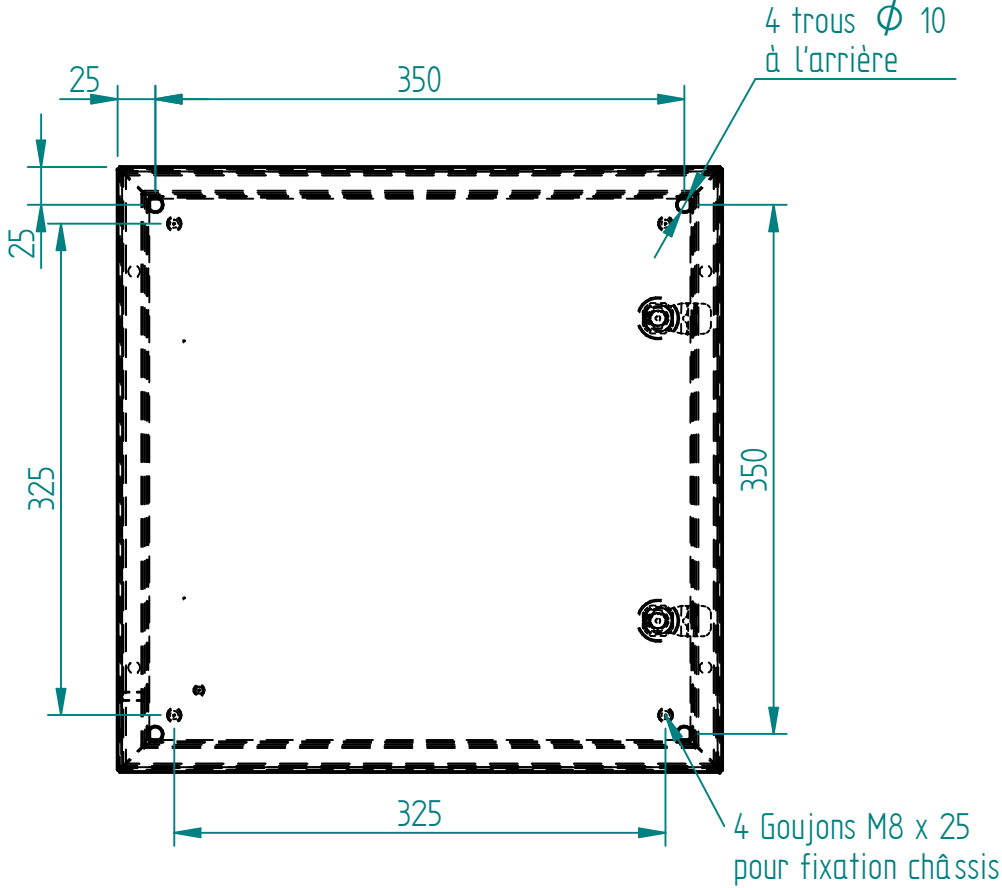
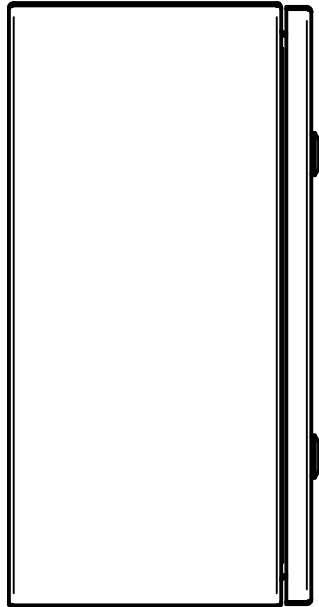
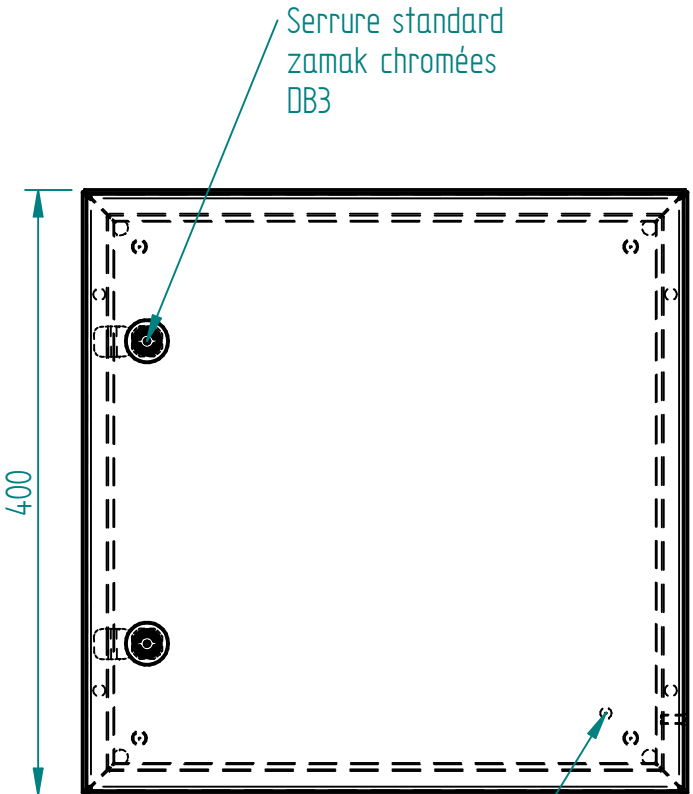
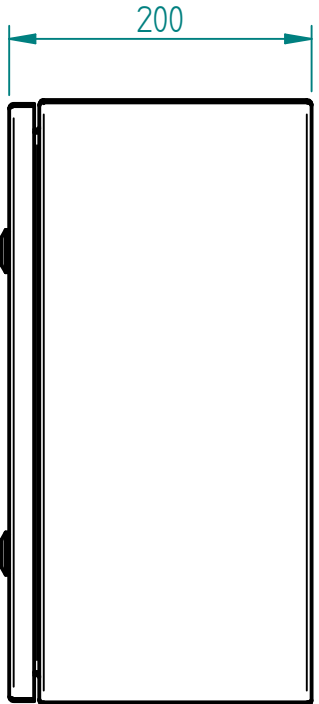
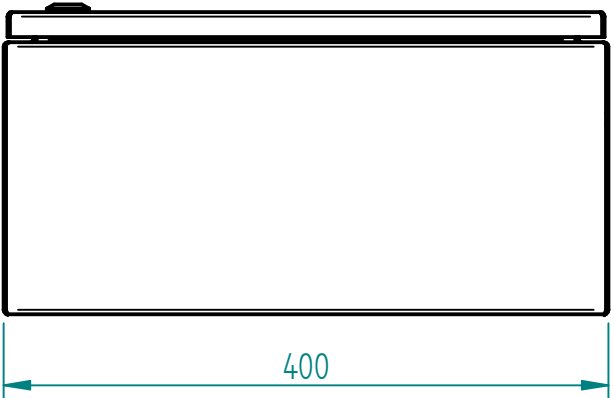

A	CLAVERIE	09/10/18	Création
Ind	Nom	Date	Commentaires
Matière :		Nom du projet :	
Echelle : 1:5		Feuille : 1 / 1	
MARBORE		Client :	
		Document n° :	
		CX6N404020 ou CY6N404020	

COFF-400x400x200

CX6N404020 ou CY6N404020