

Matière inox 304L ou 316L svt demande client
 finition microbillée ou peint svt demande client

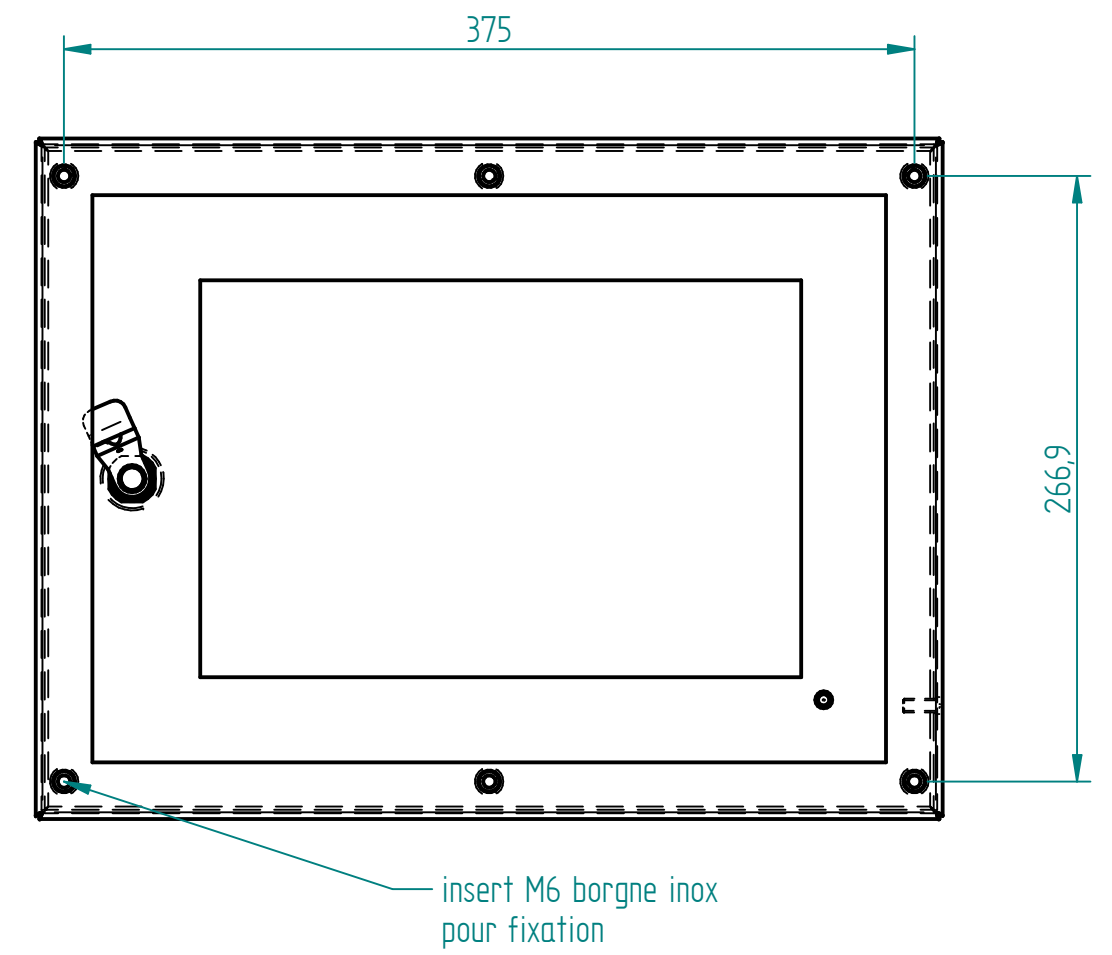

Joint EPDM extrudé 20x11 intérieur porte

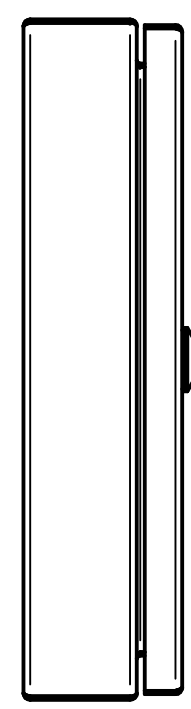
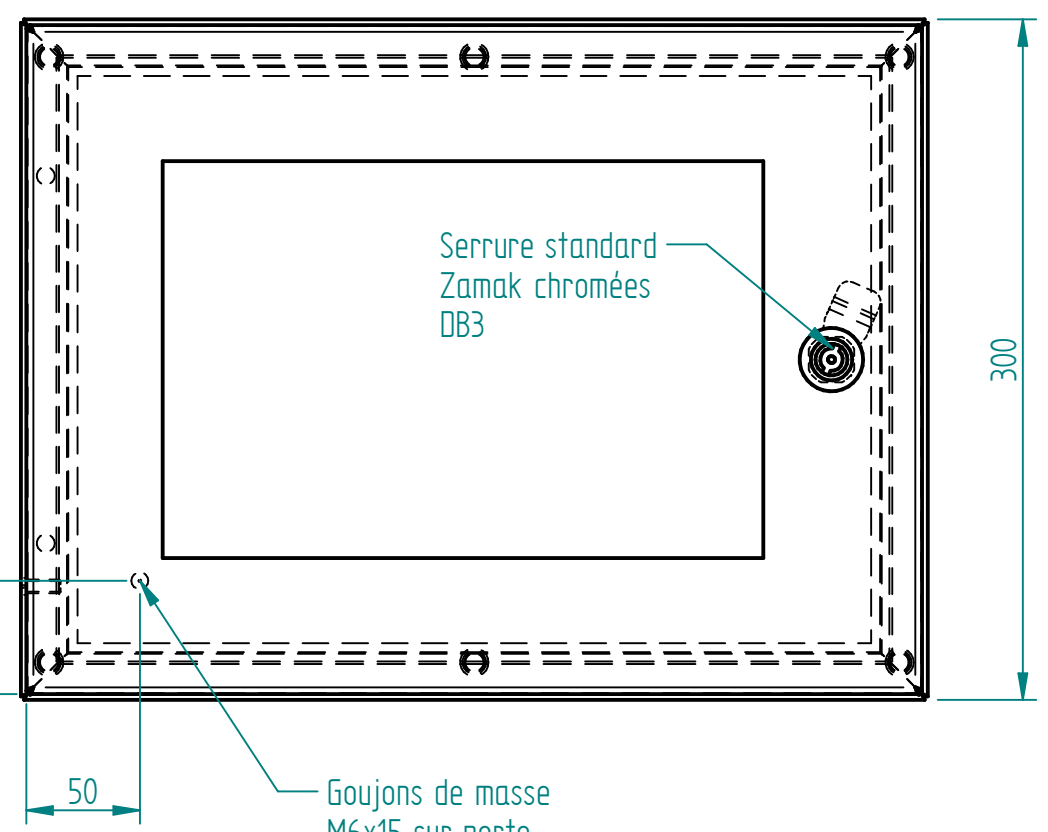
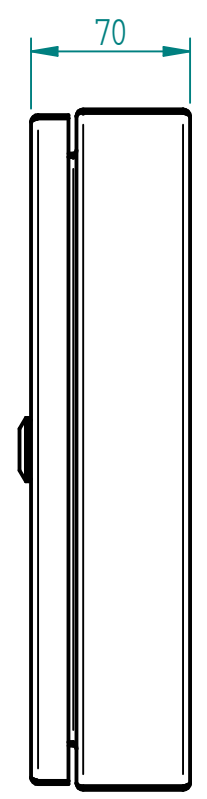
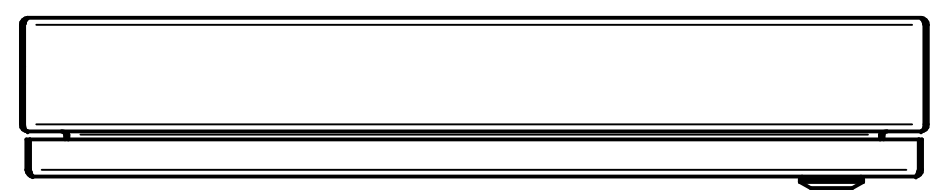
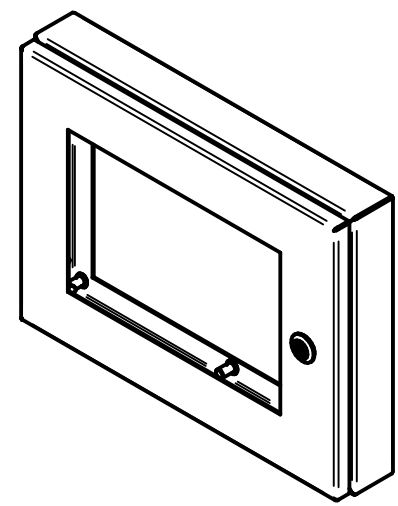

Ind	Nom	Date	Commentaires
Matière :		Nom du projet : COFF-300X400X70	
Echelle : 1:3.33	Feuille : 1 / 1	Client :	
		Document n° : OXHU3040 ou OYHU3040	
MARBORE			