

COUPE A-A

Traverses pour fixation châssis

plaque passe cable

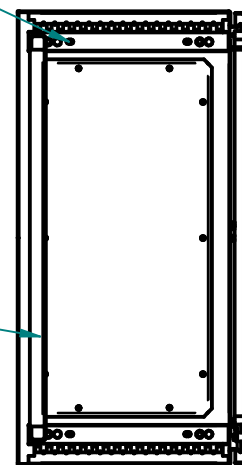

Matière inox 304L ou 316L svt demande client
 finition microbillée ou peint svt demande client

Joint EPDM extrudé 20x11 intérieur porte

Socle INOX 316L en option

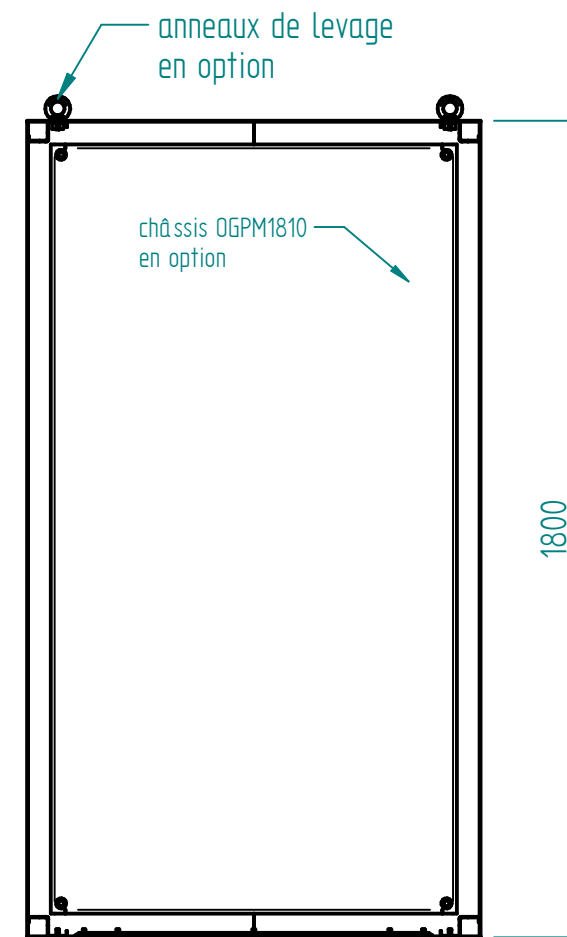
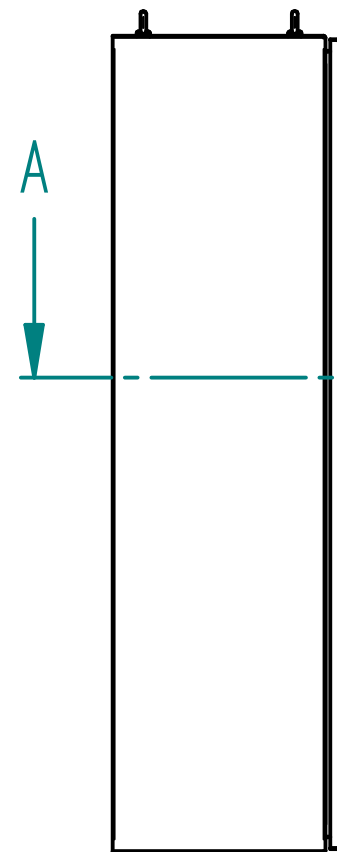
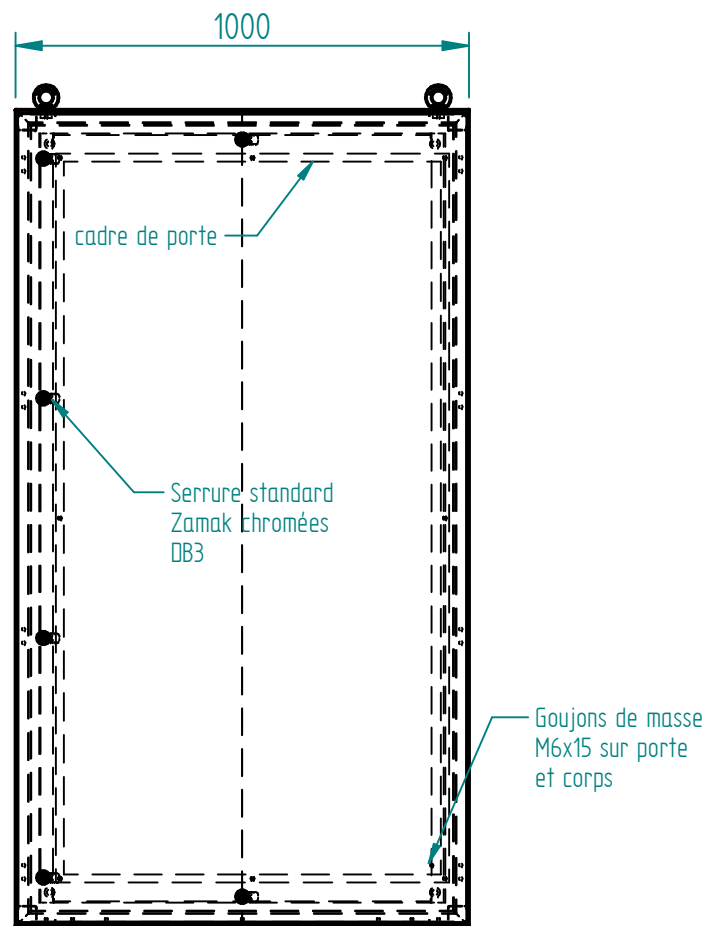
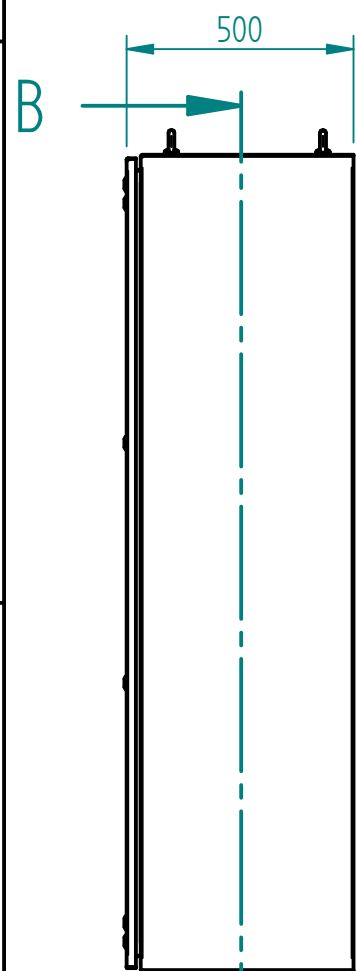

COUPE B-B

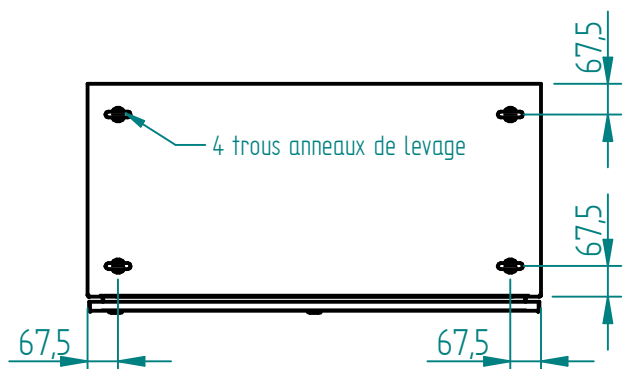
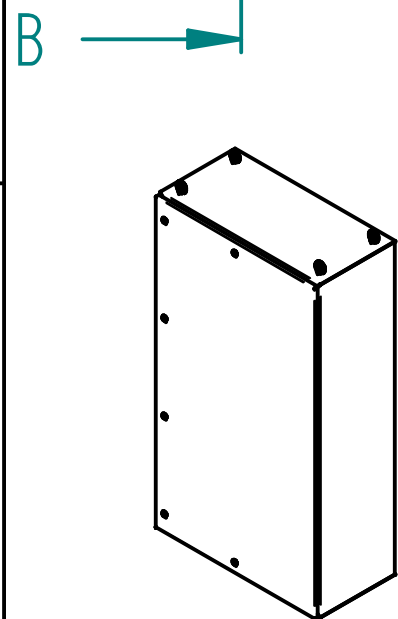

A	CERVERA	26/02/19	Création
Ind	Nom	Date	Commentaires
Matière :		Nom du projet : ARM-MONO-IP66-1800x1000x500	
Echelle : 1:16.67	Feuille : 1 / 1		
		Client :	
MARBORE		Document n° : AX6N181050 ou AY6N181050	