

COUPE A-A

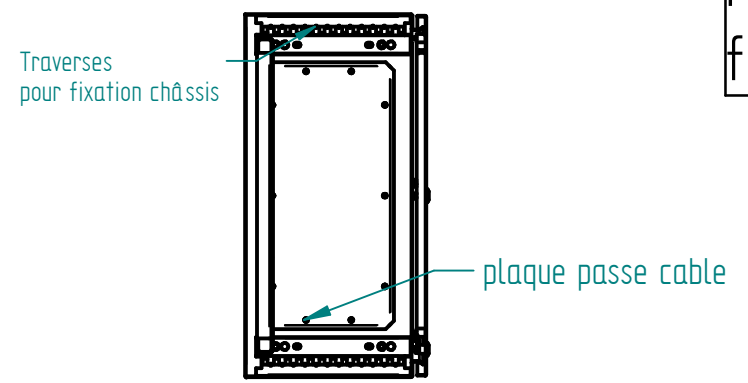

Matière inox 304L ou 316L svt demande client
 finition microbillée ou peint svt demande client

Joint EPDM extrudé 20x11 intérieur porte

Socle INOX 316L en option

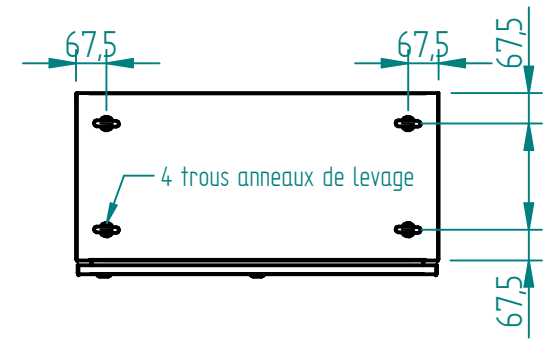
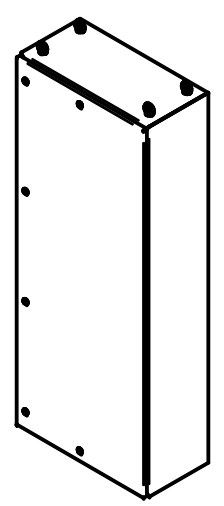
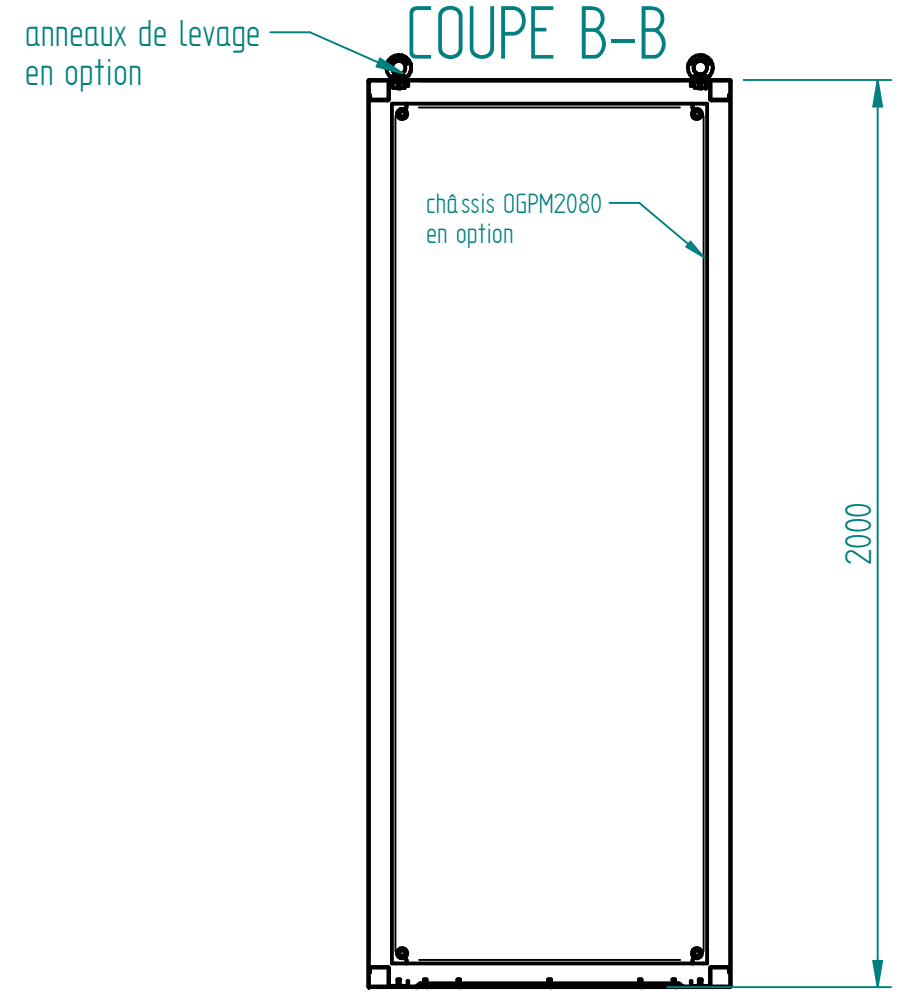
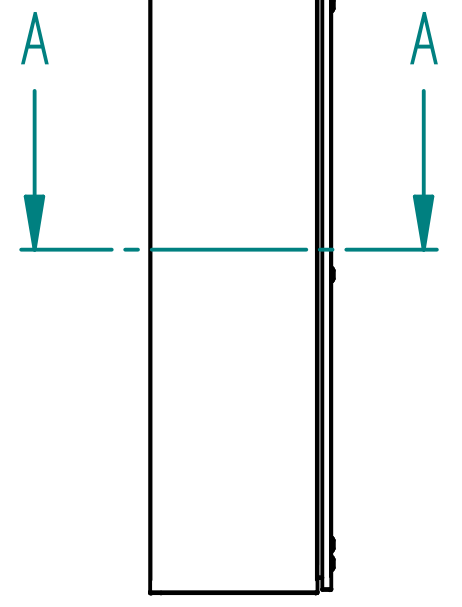
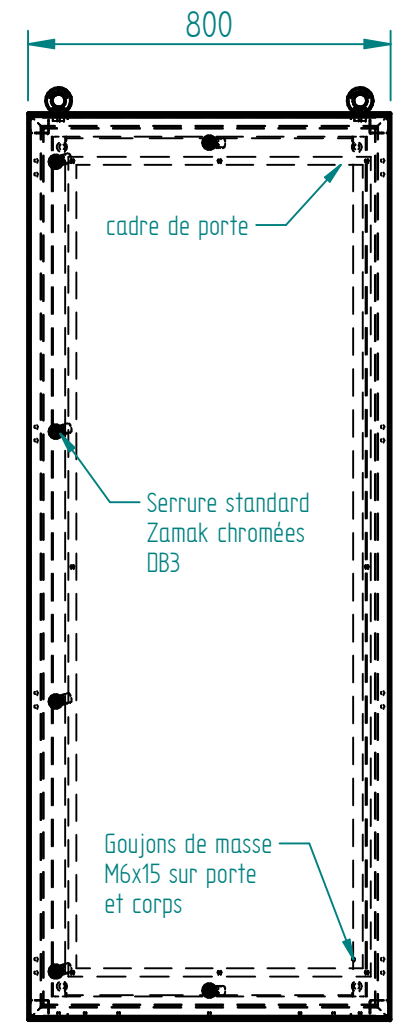
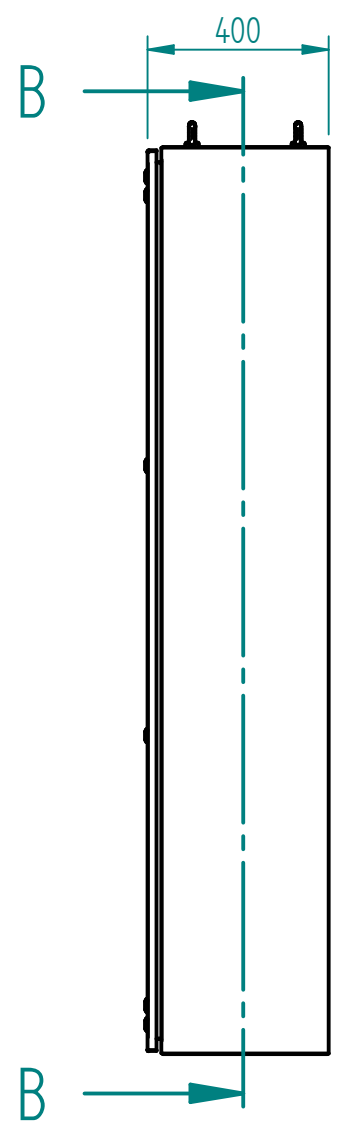

A	CERVERA	26/02/19	Création
Ind	Nom	Date	Commentaires
Matière :		Nom du projet : ARM-MONO-IP66-2000x800x400	
Echelle : 1:16.67	Feuille : 1 / 1	Client :	
		Document n° : AX6N208040 ou AY6N208040	
MARBORE			