

traverses pour fixation châssis

COUPE A-A

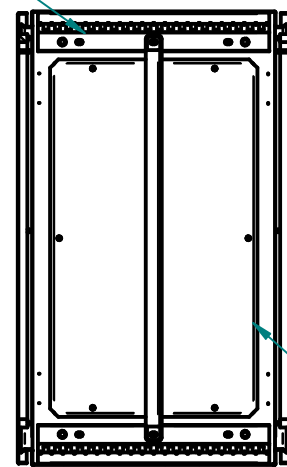

plaque passe cable

Matière inox 304L ou 316L svt demande client
 finition microbillée ou peint svt demande client

Joint EPDM extrudé 20x11 intérieur porte

Socle INOX 316L en option

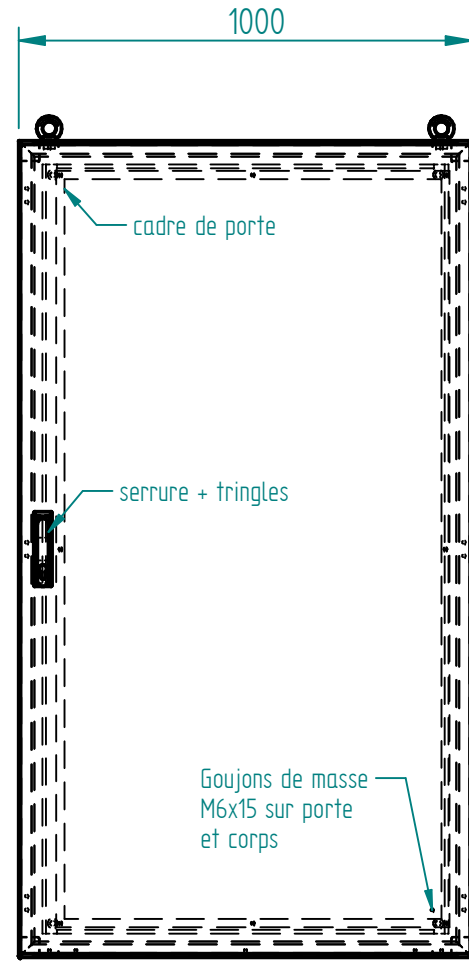
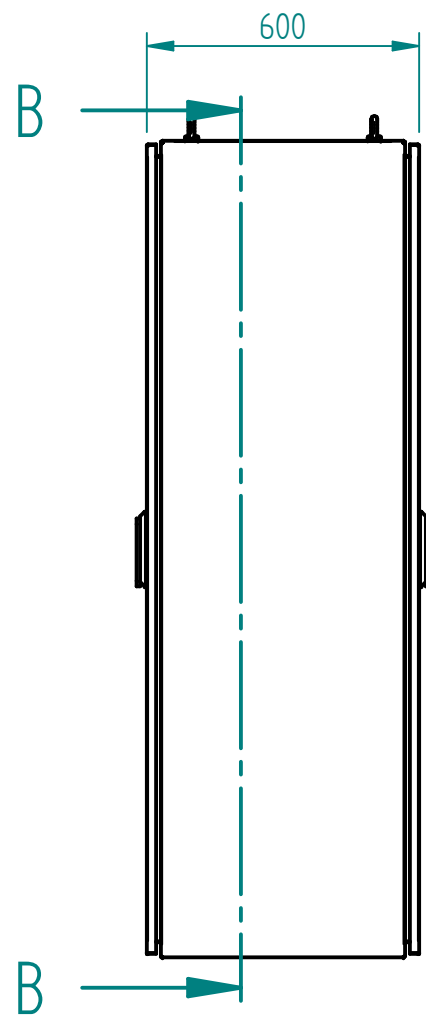

anneaux de levage en option

COUPE B-B

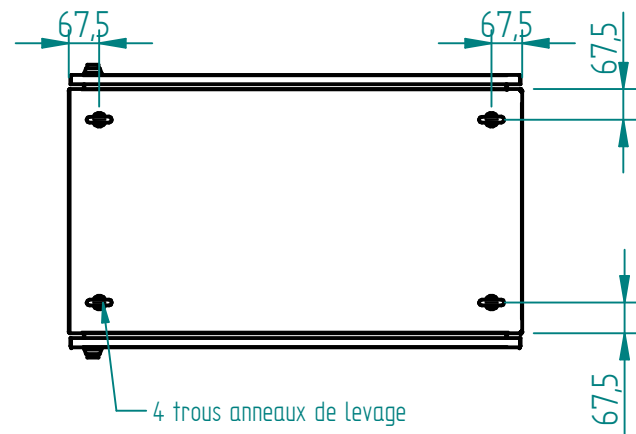
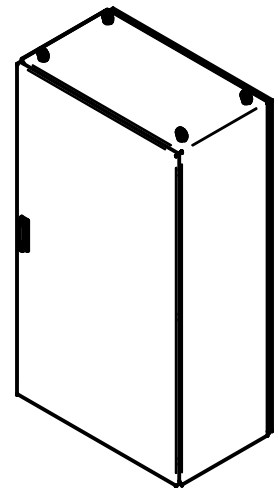
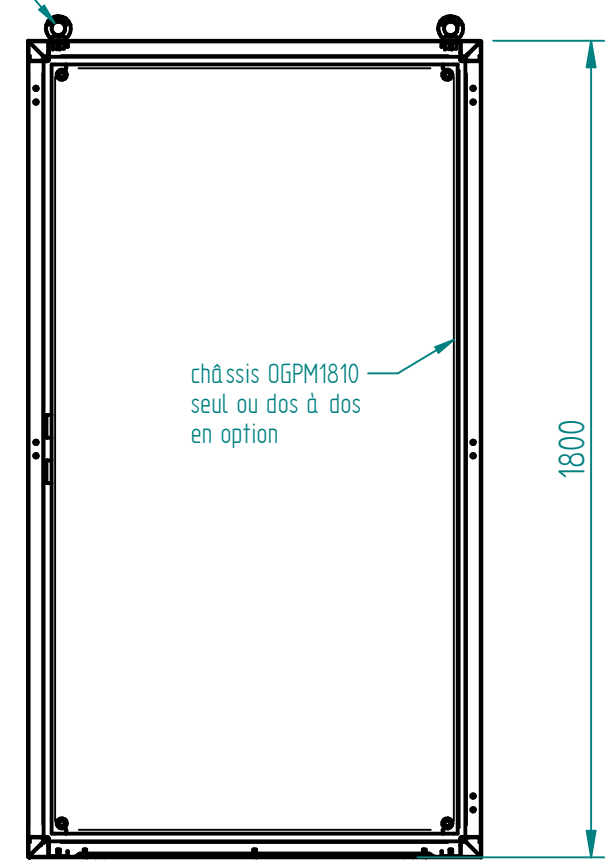
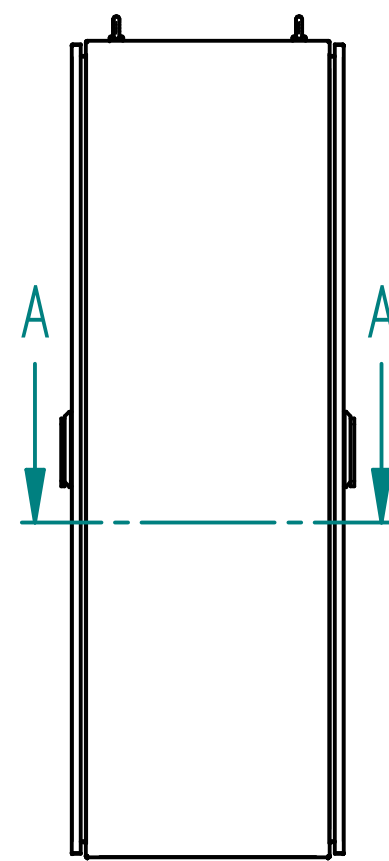

A	CERVERA	18/04/19	Création
Ind	Nom	Date	Commentaires
Matière :		Nom du projet :	
Echelle : 1:16.67		Feuille : 1 / 1	
MARBORE		Client :	
		Document n° : AXPA181060 ou AYPA181060	
		ARM-AV-AR-1800x1000x600	