

COUPE A-A

traverses pour fixation châssis

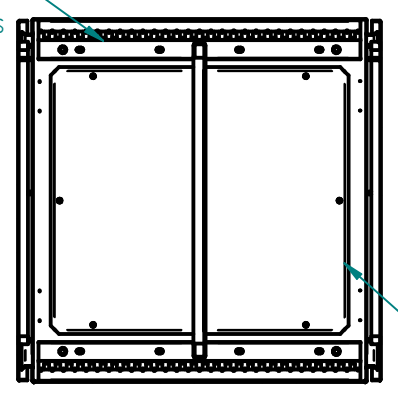

plaque passe cable

Matière inox 304L ou 316L svt demande client  
 finition microbillée ou peint svt demande client

Joint EPDM extrudé 20x11 intérieur porte

Socle INOX 316L en option

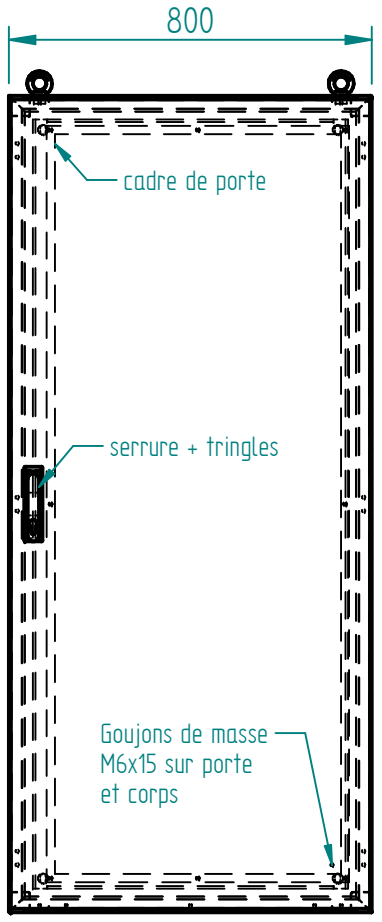
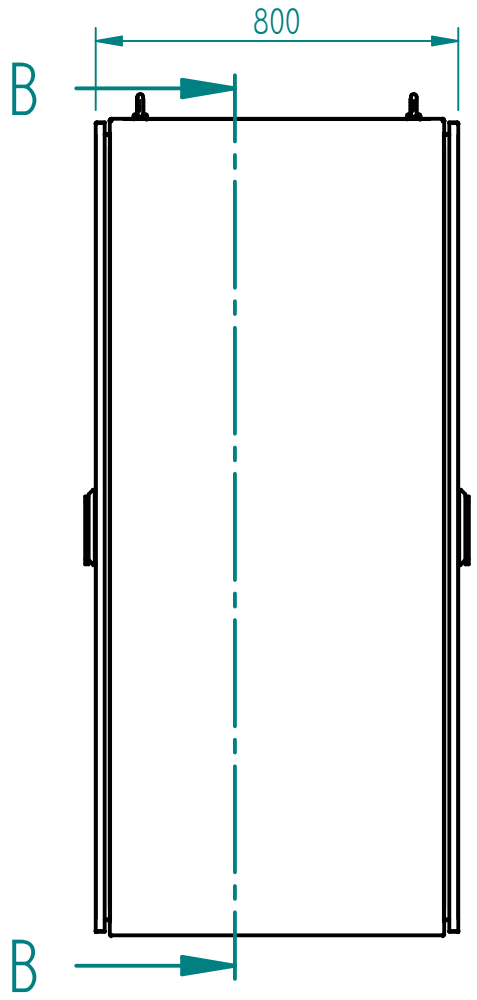

Goujons de masse M6x15 sur porte et corps

COUPE B-B

anneaux de levage en option

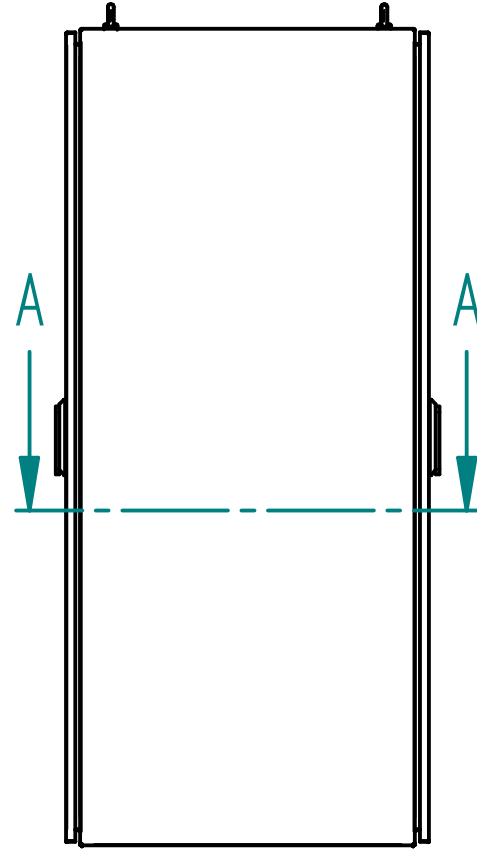

châssis OGPM1880 seul ou dos à dos en option

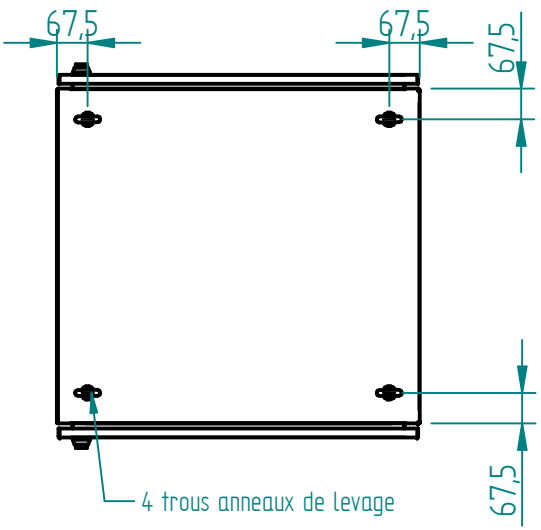
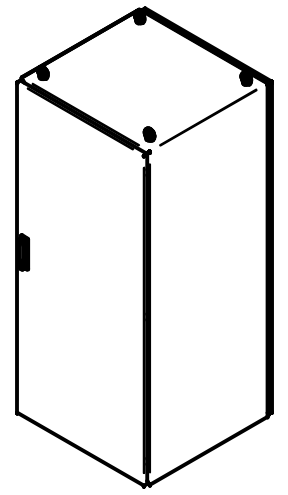
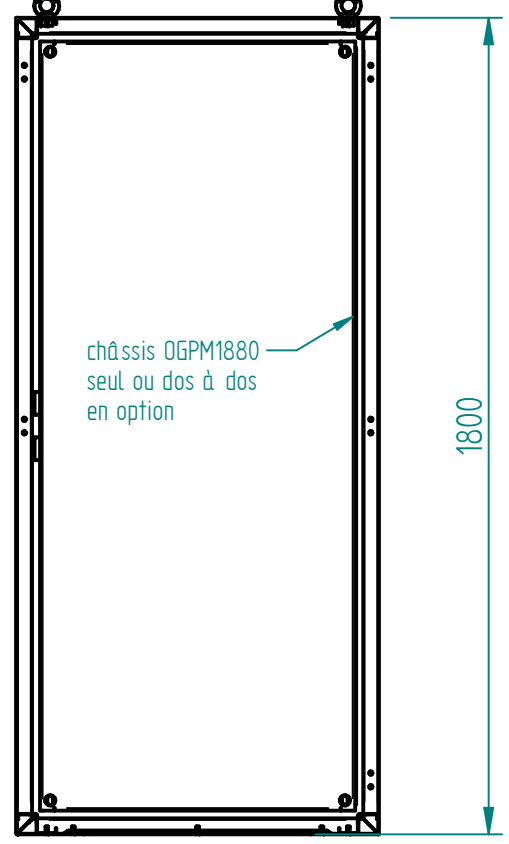

4 trous anneaux de levage

A	CERVERA	18/04/19	Création
Ind	Nom	Date	Commentaires
Matière :		Nom du projet :	
Echelle : 1:16.67		Feuille : 1 / 1	
		Client :	
MARBORE		Document n° : AXPA188080 ou AYPA188080	

**ARM-AV-AR-1800x800x800**