

COUPE C-C

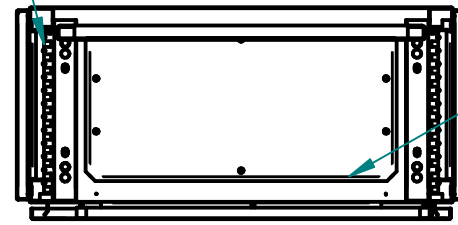

Matière inox 304L ou 316L svt demande client
 finition microbillée ou peint svt demande client

Joint EPDM extrudé 20x11 intérieur porte

joint 9 x3 périphérie porte

kit juxtaposition en option

Socle INOX 316L en option

COUPE B-B

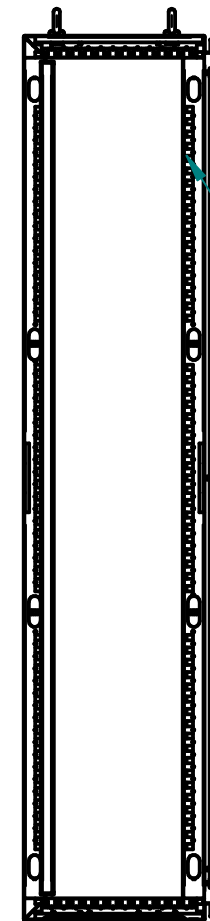

COUPE A-A

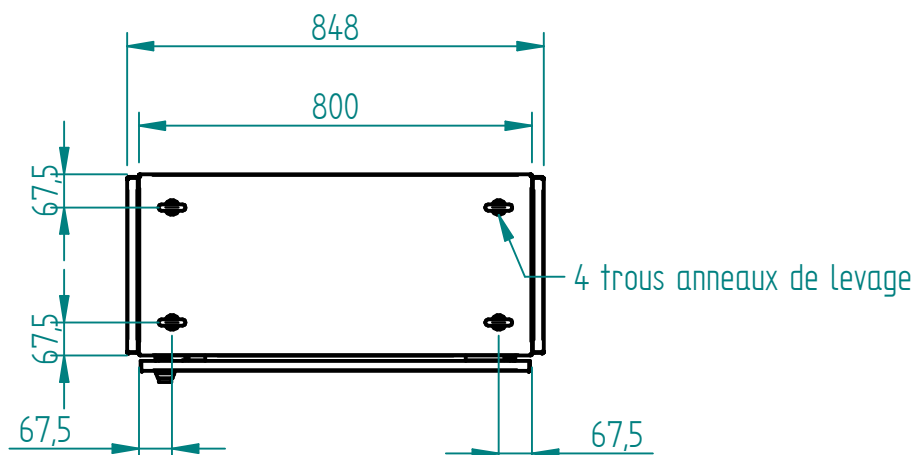
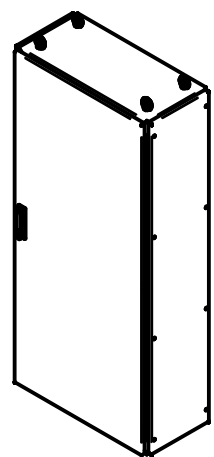
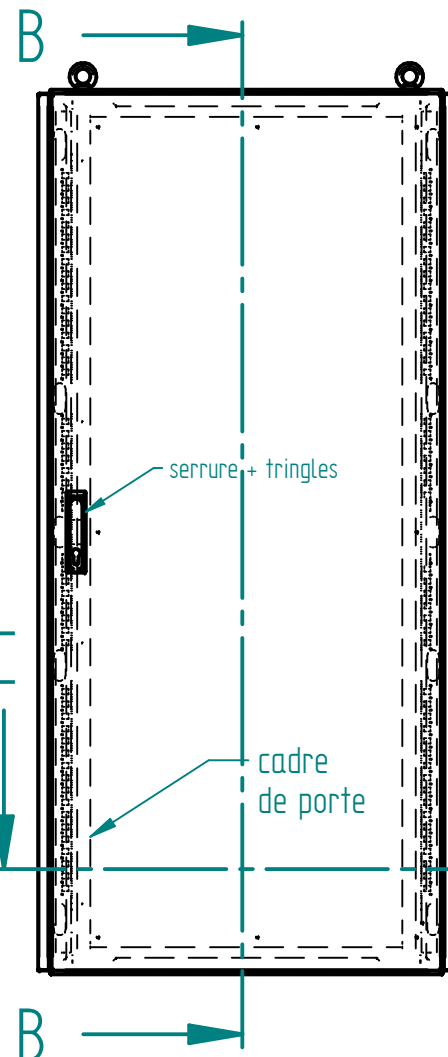
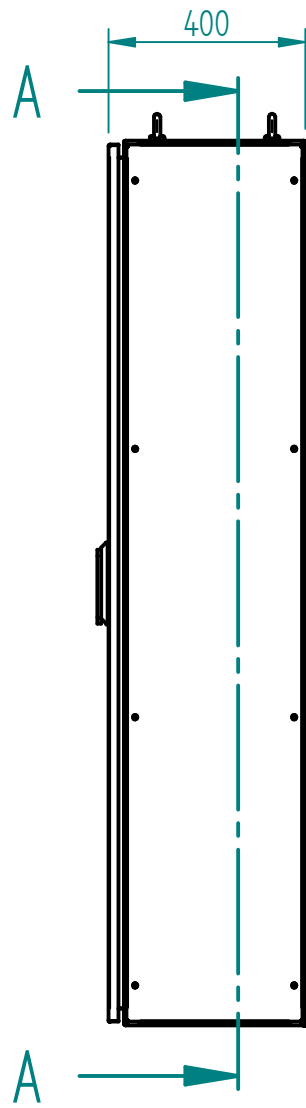
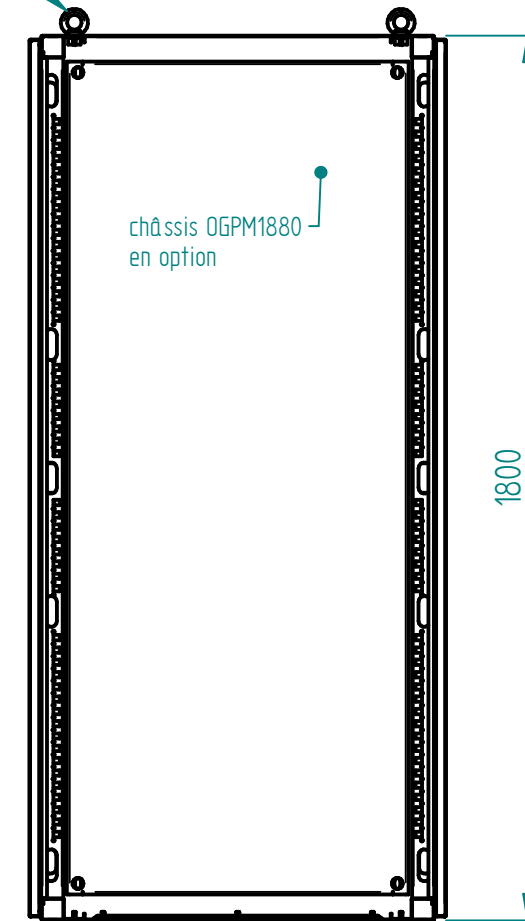

A	CERVERA	24/06/19	Création
Ind	Nom	Date	Commentaires
Matière :		Nom du projet : CELLULE-1800x800x400	
Echelle : 1:15.38	Feuille : 1 / 1	Client :	
MARBORE		Document n° : QXPN188040 ou QYPN188040	