

Traverses pour fixation châssis

COUPE C-C

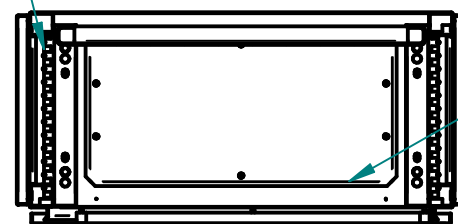

plaque passe cable

Matière inox 304L ou 316L svt demande client  
 finition microbillée ou peint svt demande client

Joint EPDM extrudé 20x11 intérieur porte

joint 9 x3 périphérie porte

kit juxtaposition en option

Socle INOX 316L en option

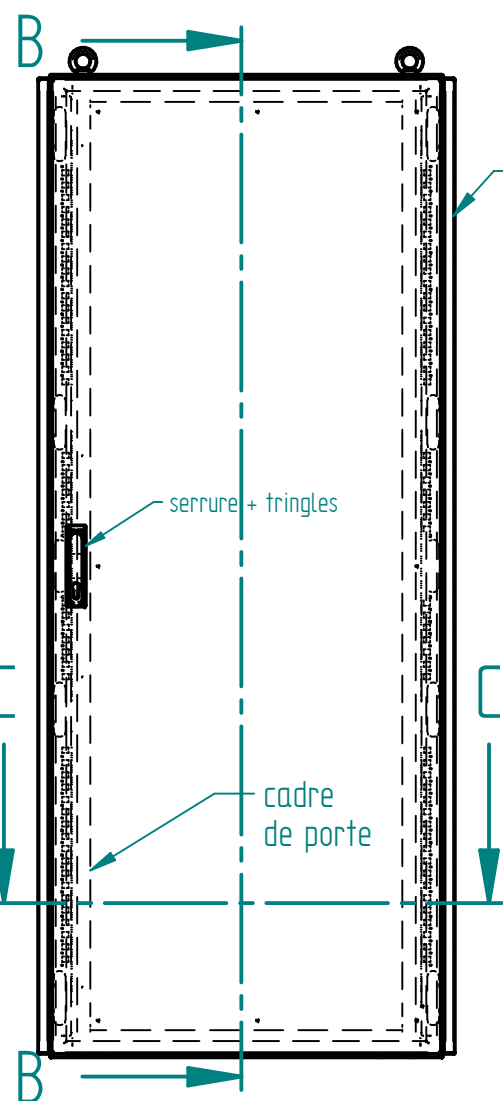
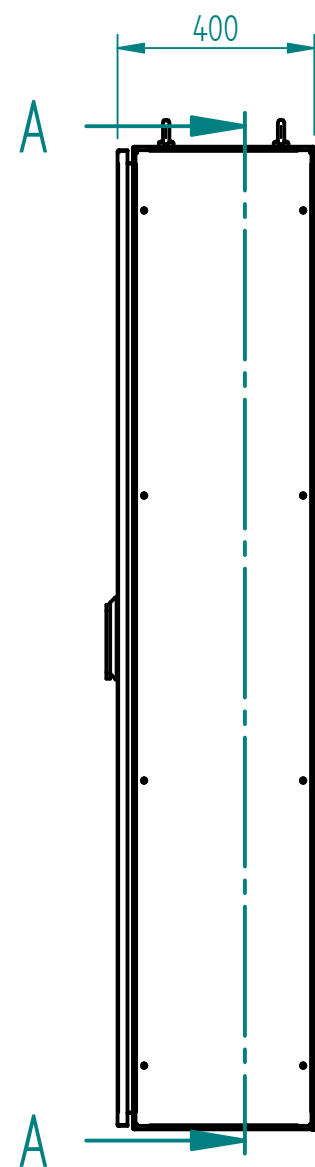

panneau latéral OXPL2040 en option

serrure + tringles

cadre de porte

COUPE B-B

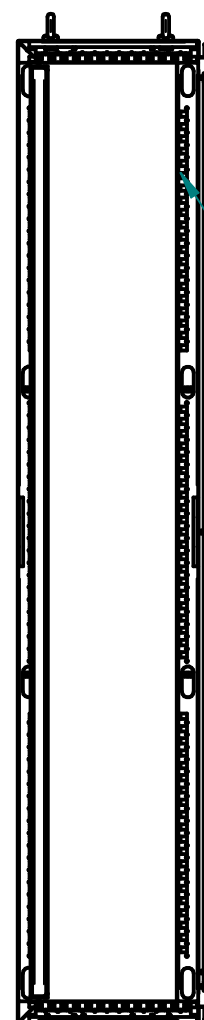

anneaux de levage en option

montant renfort

COUPE A-A

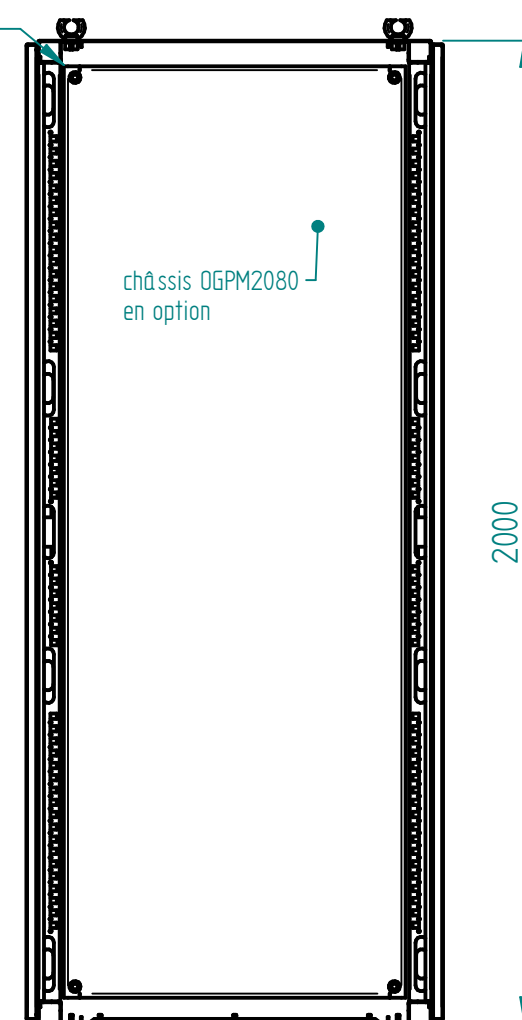

châssis OGPM2080 en option

2000

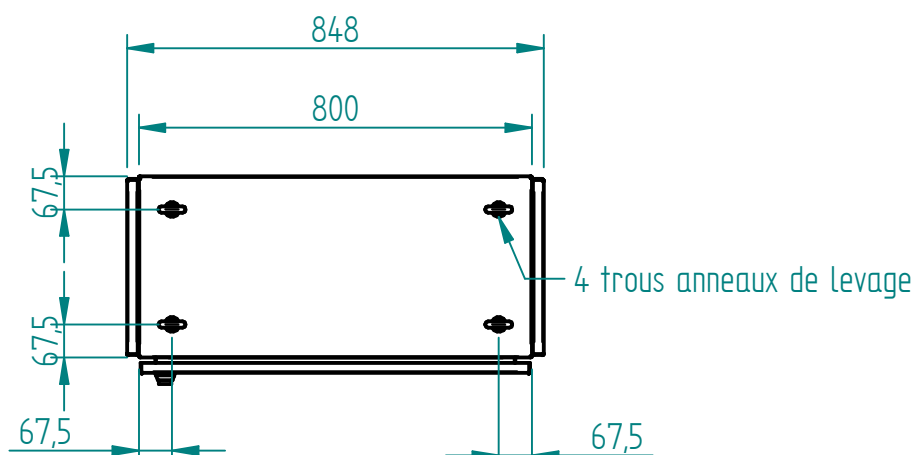
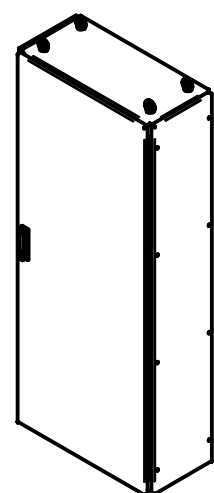

4 trous anneaux de levage

A	CERVERA	24/06/19	Création
Ind	Nom	Date	Commentaires
Matière :		Nom du projet : <b>CELLULE-2000x800x400</b>	
Echelle : 1:15.38	Feuille : 1 / 1	Client :	
MARBORE		Document n° : QXPN208040 ou QYPN208040	