

Matière inox 304L ou 316L svt demande client

Joint EPDM 20x9 intérieur
Joint silicone FDA BLEU extérieur

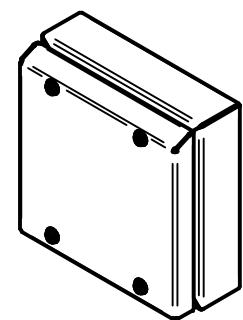
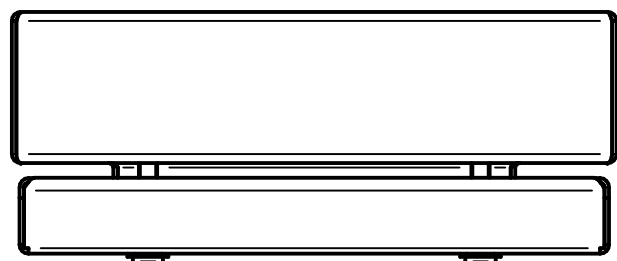
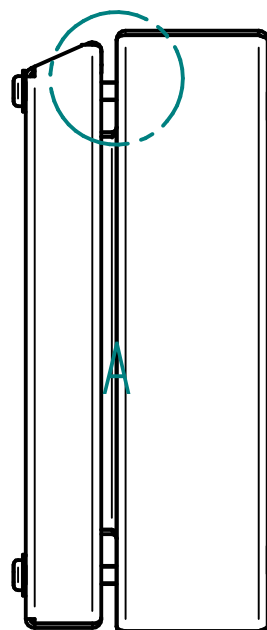
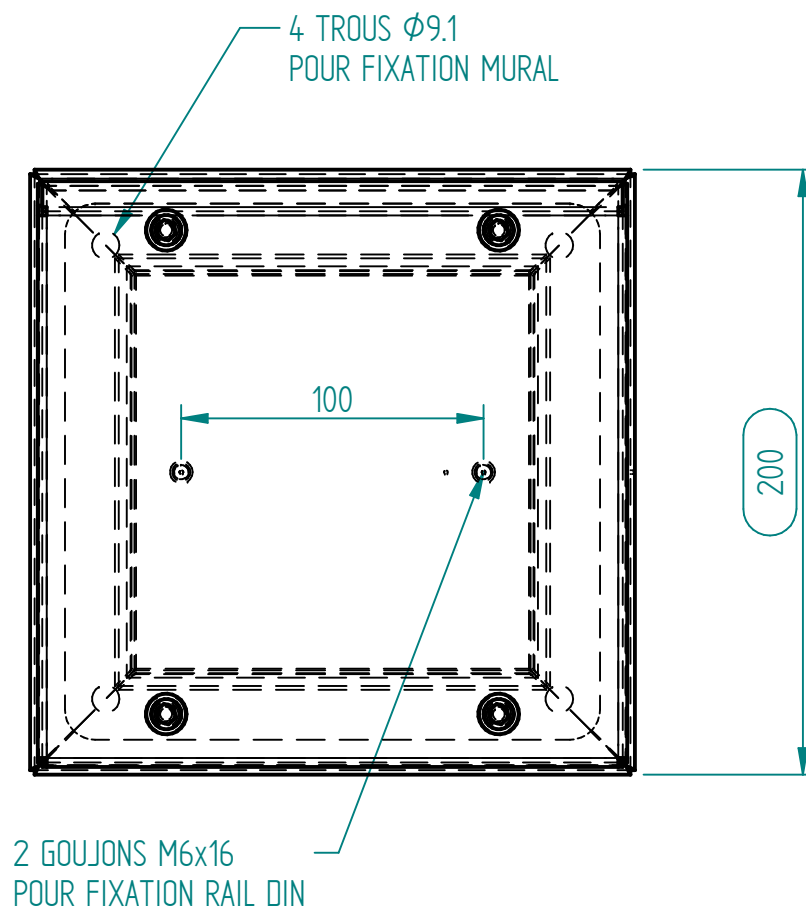
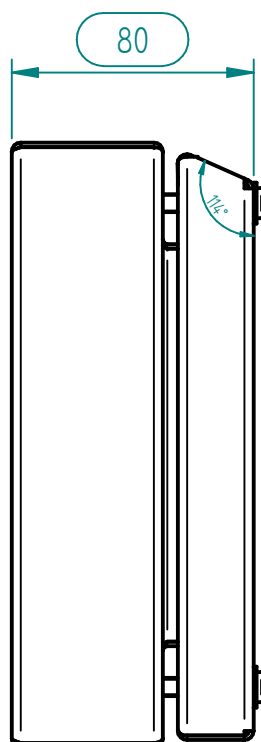
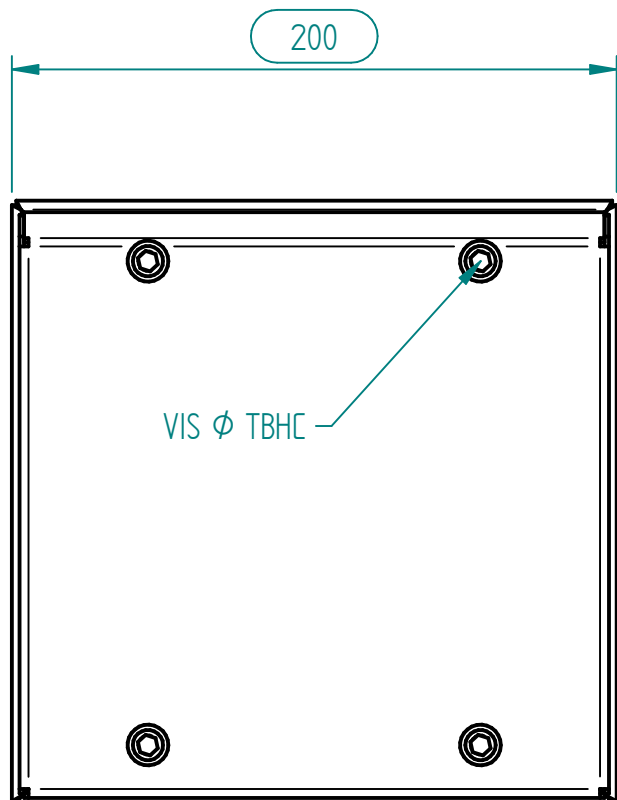
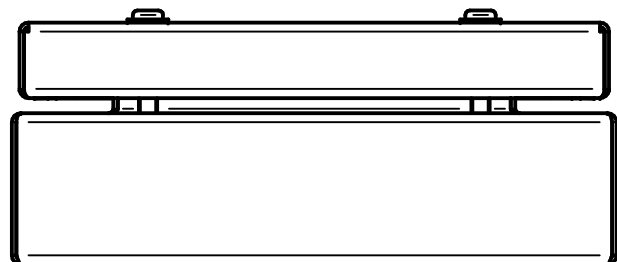
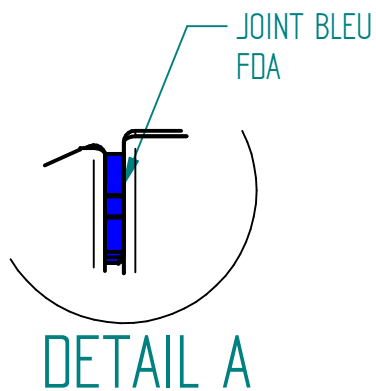

A	CERVERA	20/10/2021	Création
Ind	Nom	Date	Commentaires
Matière :		Nom du projet :	
Echelle : 1:1		Feuille : 1 / 1	
BOITIER-HD-200x200x80-1.5		Client :	
MARBORE		Document n° : BX6H202008 ou BY6H202008	