

MATIERE INOX 304L OU 316L SUIVANT DEMANDE CLIENT
EP 1.5 FINITION MICROBILLE OU PEINT

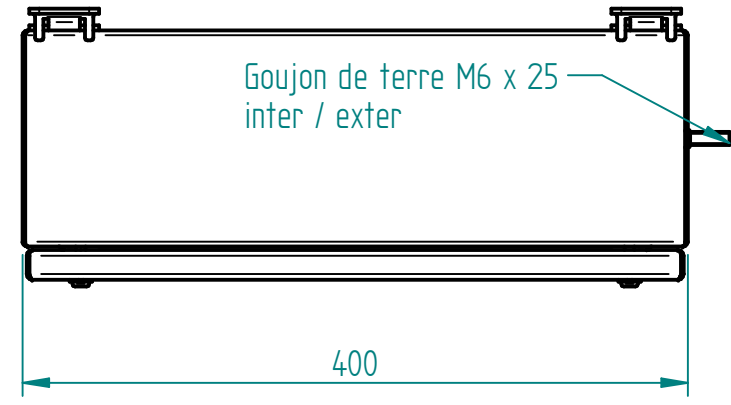
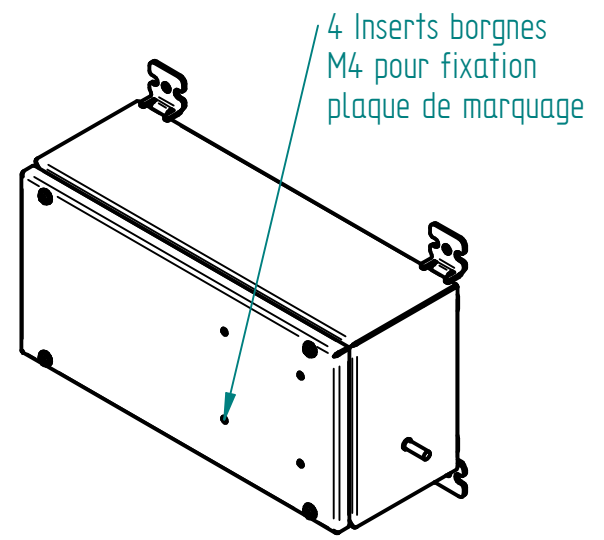
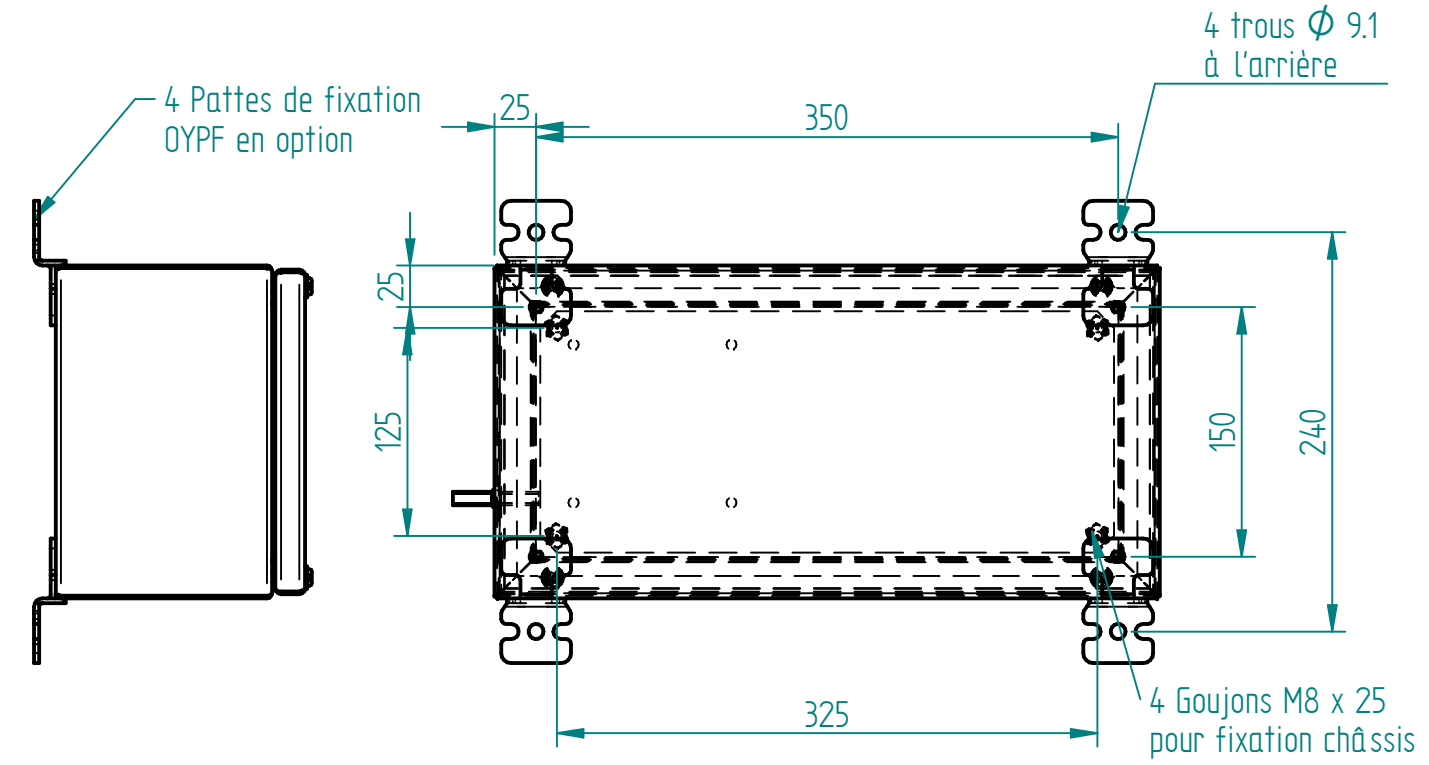
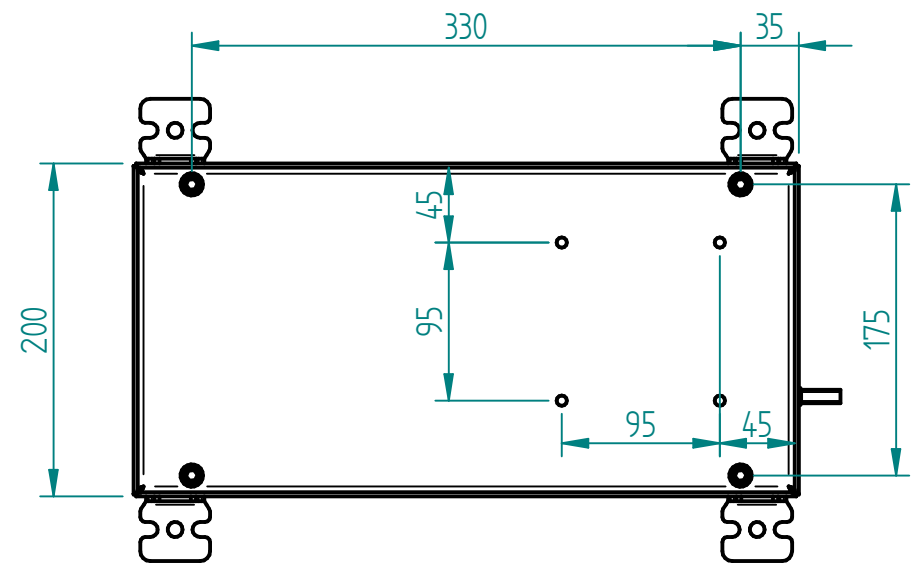
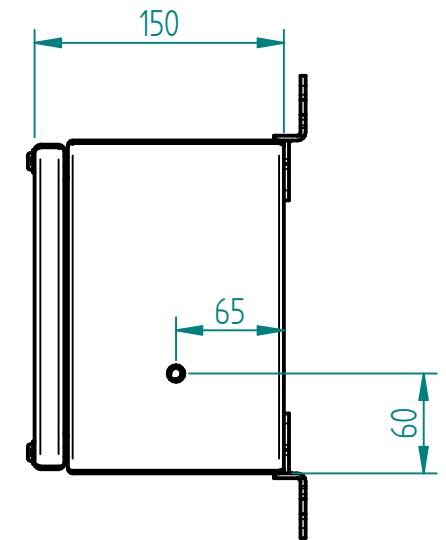
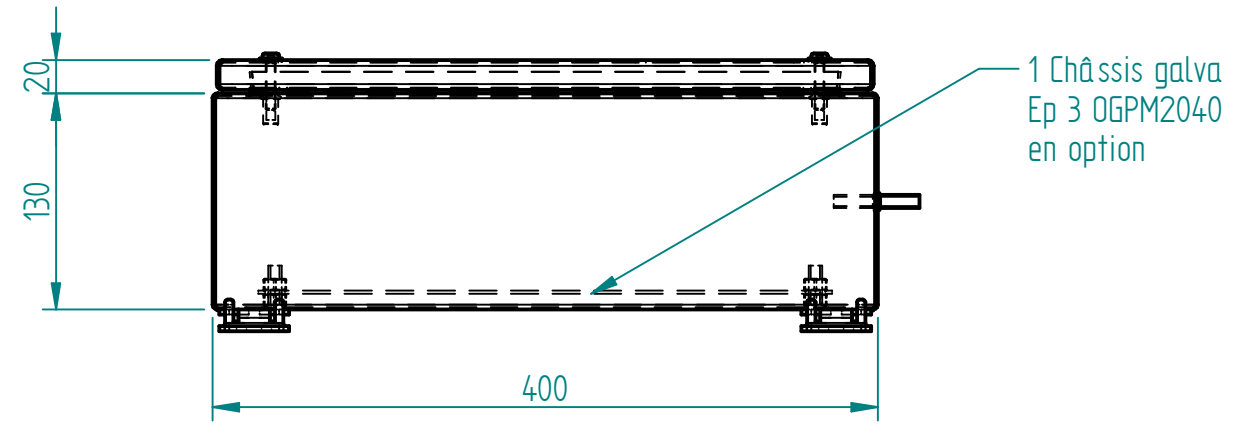

A	CLAVERIE	03/04/19	Création
Ind	Nom	Date	Commentaires
Matière :		Nom du projet :	
Echelle : 1:4.55		BOITIER-200x400x150	
Feuille : 1 / 1		Client :	
		Document n° :	
MARBORE		BXA204015 - BYA204015	