

Matière inox 304L ou 316L Ep 1.5 finition microbillée ou peint

1 Châssis OGPM3030 en option

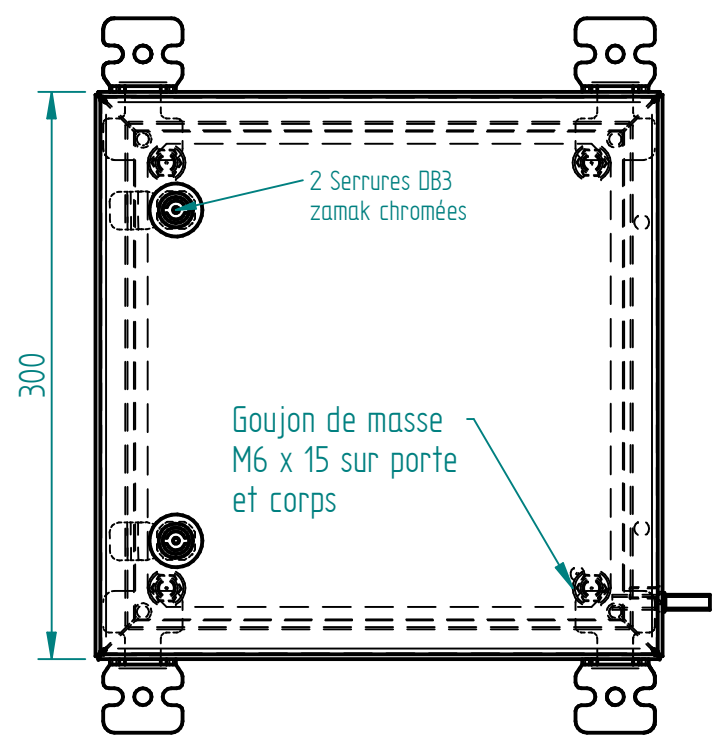

4 Pattes de fixation OYPF en option

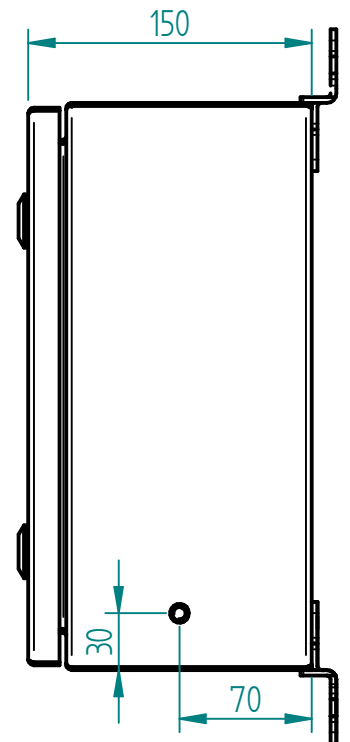
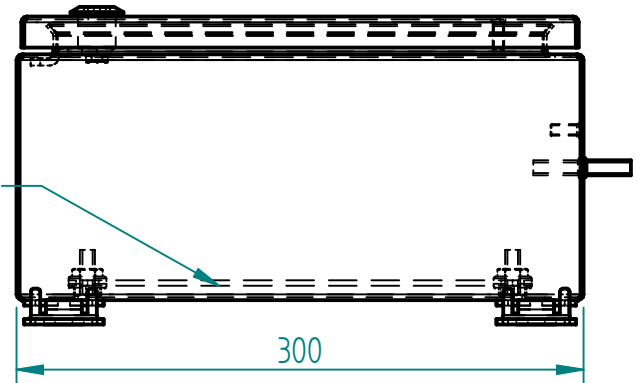
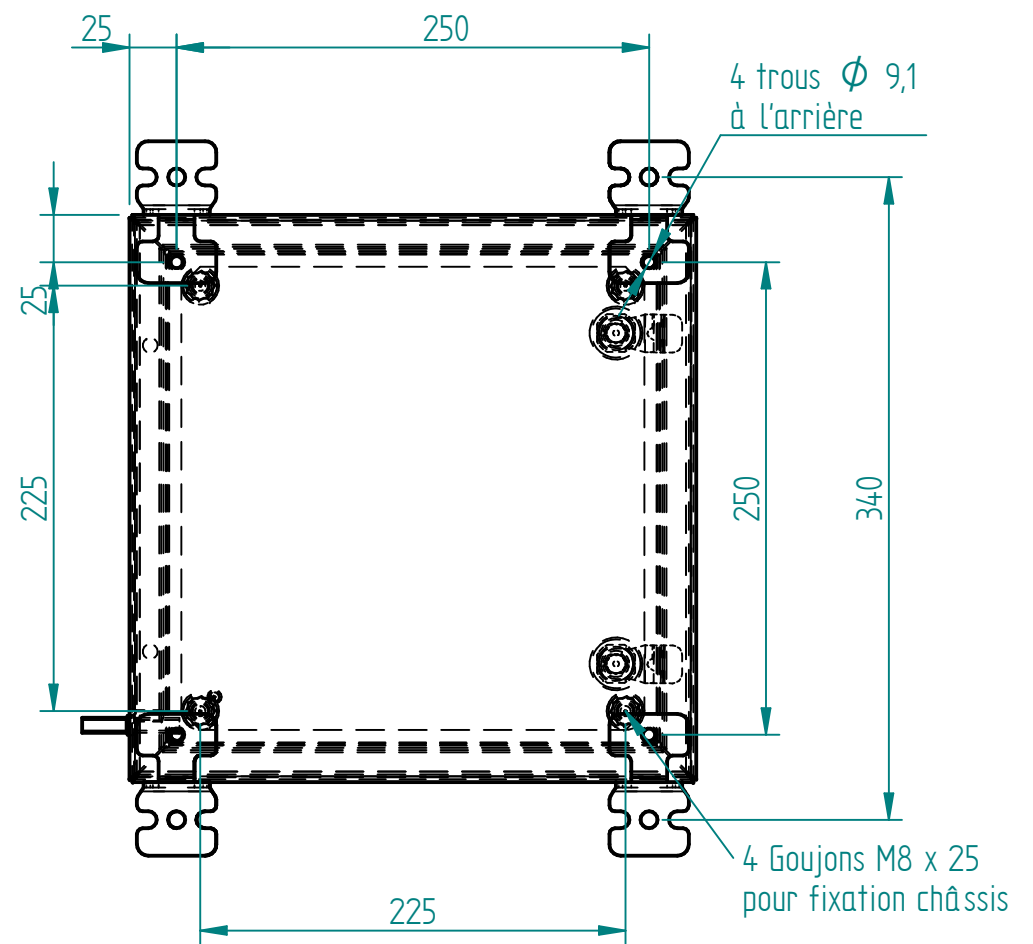
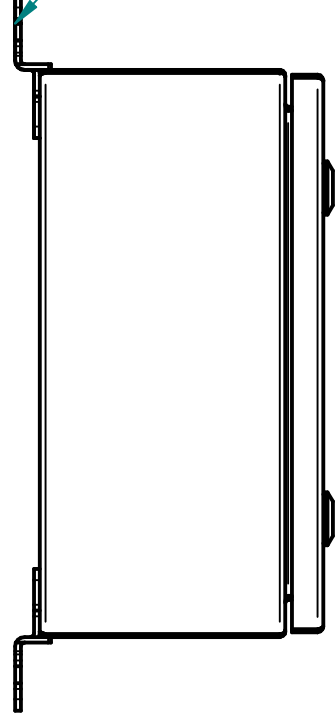

1 Goujon de masse M8 x 25 inter / exter

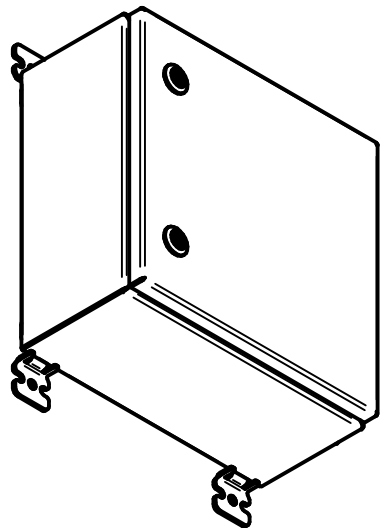
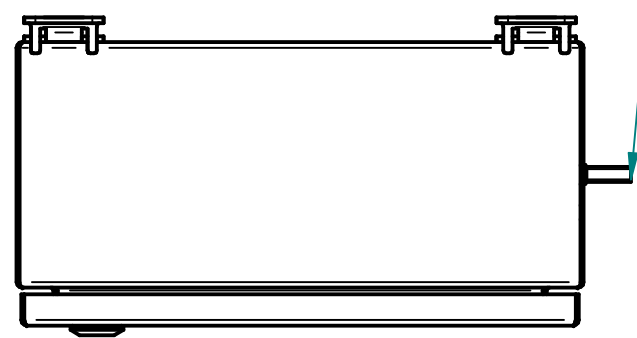

A	CLAVERIE	11/06/19	Création
Ind	Nom	Date	Commentaires
<b>ATEX</b>		Nom du projet : <b>COFF-ATEX-300x300x150</b>	
Echelle : 1:4	Feuille : 1 / 2	Client :	
		Document n° : <b>PLAN-CXAx&amp;CYAx-303015</b>	
<b>MARBORE</b>			